



DO IT YOURSELF

Contemporary Craftsman Trim

Skill Level



Estimated Cost

\$200

Time



Download PDF





Contemporary Craftsman Trim

The Craftsman Movement was an architectural style from the 1890's through the 1930's. The Craftsman style was a stark departure from its predecessor, the Victorian Style. The Victorian era embraced the advancement in the American manufacturing industry and mass production, utilizing over the top details and elaborate embellishments. An example for the Victorian Home would be the Painted Ladies in San Francisco.

The American Craftsman style, influenced by the British Arts and Crafts movement, was a response to the Industrial Revolution in Europe thought to dehumanize labor. The movement focused on clean, simple lines, emphasizing joinery, and artisanship. Examples of these homes are Bungalow, Mission, Four-Square, and Prairie. As for influencers: Gustav Stickley, Charles and Henry Green as well as Frank Lloyd Wright played key roles in developing this style and are worth researching for inspiration.

The Craftsman Style exterior included:

- Tapered Columns
- Visible Knee Braces — Triangle supports that support the roof eave
- Oversized Roof Eaves

The Craftsman Style interior included:

- Built-In Cabinetry, Window seats and shelving
- Boxed Beam Ceilings
- Thick Trim Around Windows and Doors

Royal has tagged this trim package “Contemporary Craftsman” due to the undersized profiles. These sizes are more economical and lend themselves to smaller spaces. The profile thickness is designed to provide the proper level between casing and base, for a more traditional build.

Style & Design

The Craftsman Trim program intention is to provide a palate of profile to create various styles. Use in conjunction with other profiles and materials to create unique trims. Here are a few samples illustrated:

Simple — Off the shelf profiles assembled in an historical arrangement The Craftsman Style exterior included:

- Header — 5-1/4" Casing
- Sill & Apron — 2-1/4" Casing
- Base & Jamb — 3-1/4" Casing and 4-1/4" Base

Additional Profiles — Adding cove and quarter round to enhance the look and function.

- Header — 5-1/4" Casing, 3/4" Cove & 3/8" Flat Trim
- Sill & Apron — 5-1/4" Sill & 2-1/4" Casing
- Base & Jamb — 3-1/4" Casing, 4-1/4" Base & 1/2" Quarter Round

Modified Profiles — Changing the width of the profiles allows for further variations.

- Header — 5-1/4" Casing, 4-1/4" Base ripped to custom width
- Sill & Apron — 5-1/4" Sill (Reversed) & 3-1/4" Casing
- Base & Jamb — 3-1/4" Casing, 4-1/4" Base & 3/8" Flat Casing

We will be install the modified version, based on a traditional Craftsman Bookcase. This will show the versatility of the product and cover a verity of installation/ assembly techniques. Testing the concept by building a 12 inch head assemble and suspending it on a door frame will provide the best decision making information for both color and style.



Window/Door Header

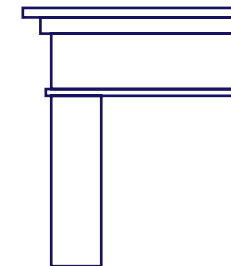
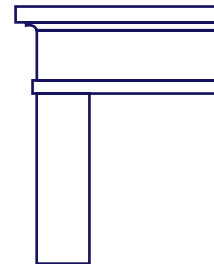
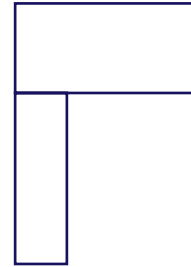

Window/Sill & Apron

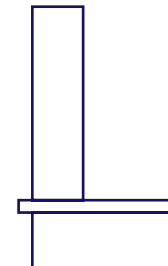
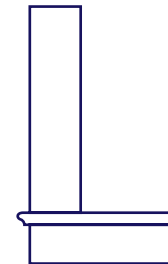
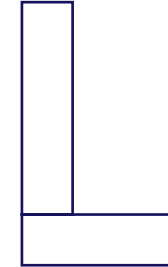

Base & Door Jamb

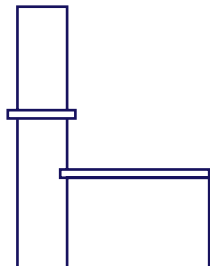
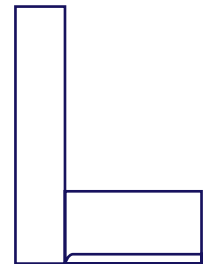
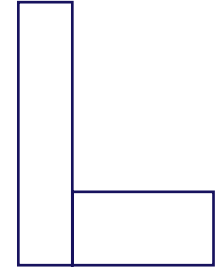

Layout & Materials

A quick sketch with a few pertinent dimensions will ensure you have the proper materials and correct profiles. Using the design diagram calculate each wall independently and total for material list.

NOTE: For door and windows, add the width of the jamb. Example: Jamb is 3-1/4" so an additional 6-1/2" is added to the header dimension.

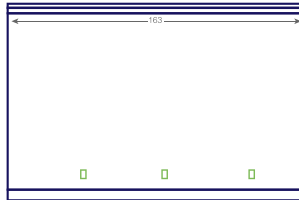
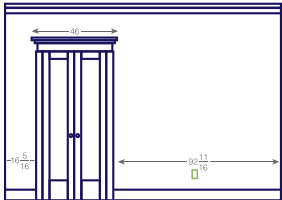

Wall #1

- 1ea - 5-1/4" X 8' Base
- 1ea - 5-1/4" X 8' Casing
- 2ea - 3-1/4" X 8' Casing
- 2ea - 1-1/4" X 8' Flat Trim

Wall #2

- 1ea - 5-1/4" X 8' Base
- 1ea - 5-1/4" X 8' Casing
- 2ea - 3-1/4" X 8' Casing
- 2ea - 1-1/4" X 8' Flat Trim

Wall #3

- 2ea - 5-1/4" X 8' Base
- 1ea - 5-1/4" X 8' Casing
- 2ea - 3-1/4" X 8' Casing
- 3ea - 1-1/4" X 8' Flat Trim
- 1ea - 2-1/4" X 8' Casing
- 1ea - 3-1/4" Base

Wall #4

- 2ea - 5-1/4" X 8' Base
- 2ea - 1-1/4" X 8' Flat Trim

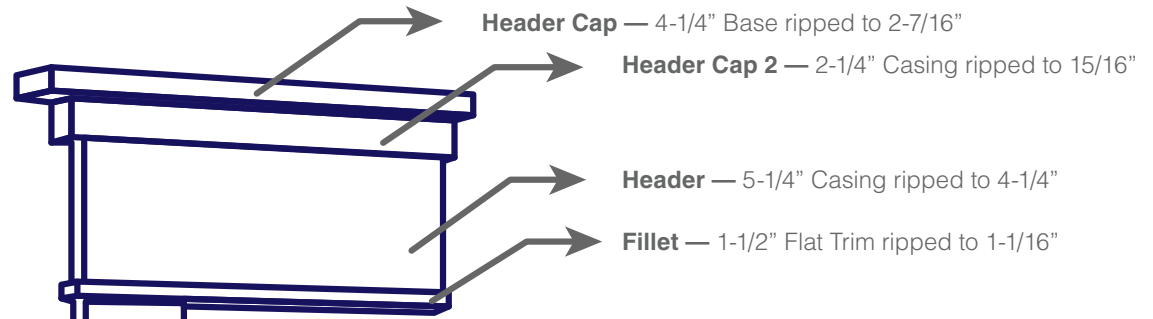
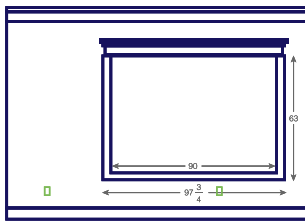
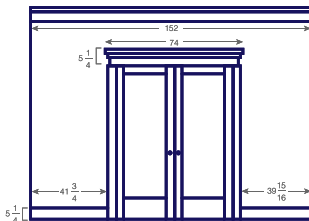

Window Door Header

Casing — 3-1/4" Casing

Casing — 3-1/4" Casing

Casing — 3-1/4" Casing

Window Jamb & Sill

Stool — 5-1/4" Reversed

Apron — 3-1/4" Casing

Jamb & Base

Casing — 3-1/4" Casing

Fillet — 1-1/2" Flat Trim ripped to 1-1/16"

Fillet — 1-1/2" Flat Trim ripped to 1-1/16"

Base — 5-1/4" Reversed

Layout & Materials

PVC has some unique characteristics differentiating it from wood. In this project, we will highlight these attributes, showing how to work with or around the product to eliminate potential issues. The two main topics are PVC's inability to absorb moisture and its ability to be chemically welded.

Moisture Absorption – PVC will not absorb moisture. This is wonderful for bathroom, kitchen and mudroom applications. The one drawback is painting; Acrylic Latex coatings will take longer to cure because the moisture has to escape through the coating, as opposed to wicking into the substrate, as does with wood. If you choose to use an Acrylic Latex the coating will dry through and adhesion will be fine.....it just takes time. To overcome this we are using coating specifically designed for quick drying. A few examples are:

- Sherwin Williams — Snap Dry
- Valspa — Trim and Cabinetry
- BEHR Premium — Cabinet and Trim

NOTE: Read the paint manufactures TDS (technical Data Sheet) for application information.

Gluing – PVC reacts a little differently than wood when it comes to gluing. PVC Cement will chemically weld with PVC Trim, making the joint stronger than the PVC substrate. Using this adhesive in conjunction with a CA adhesive (Super Glue) can eliminate the need for clamping, thus speeding the process dramatically. The one drawback is the impact the adhesive has on the painted surface causing discoloration or paint removal. To overcome this we will glue our joints prior to painting. A list of the glues used:

- Oatey — Heavy Duty clear PVC Cement (no primer required)
- 2p-10 CA glue with activator

We are also using adhesive to adhere the trim to the walls. For this application, we recommended these adhesives:

- Loctite – Power Grab
- Liquid Nails – Fuze It

Tools:

- Hearing Protection
- Safety Glasses
- Hammer
- Caulk Gun
- Power Miter Saw
- Scribing Tool
- Stud Finder
- Table Saw
- Tape Measure
- HVLP Spray Gun

Materials:

- 2” Finish Nails
- Construction Adhesive
- PVC Cement
- CA Glue
- Masking Tape
- Lightweight Spackle
- PVC Trims
- Paint

Step 1 — Pre-Cut Trims

The Craftsman Trim program intention is to provide a palate of profile to create various styles. Use in conjunction with other profiles and materials to create unique trims. Here are a few samples illustrated:

Measure & Pre-cut — this is a little unconventional, but this upfront work will pay off during the final install as well as aid in the painting process.

Stool — temporarily attach scrap casing to simulate final install on the window to calculate the sill length. (NOTE: stool will extend $\frac{1}{2}$ " beyond casing in this design)

Headers — tack up temporary casing (scrap 10") and measure for the final header length. Do not forget to add the reveal of $\frac{1}{4}$ " (illustrated below).

Plinth Detail — (bottom of door casing) – cut to 8-1/2" and add the fillet detail to the top.

Base Boards — Using the measurement from the take-off drawing, pre-cut or assemble the Trims to required lengths leaving about $\frac{1}{2}$ ' extra for removal during final install.

Casings — Pre-cut casing to required lengths leaving about $\frac{1}{2}$ ' extra for removal during final install.

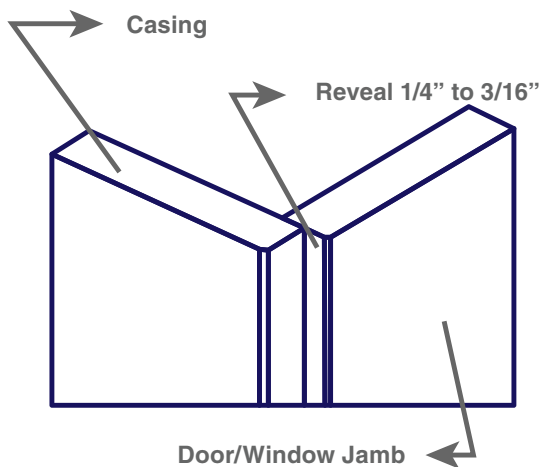

Measuring



Glue Up Longer Lengths

Cut Scarf Joint



Glue



Assemble



Step 1 — Pre-Cut Trims

Headers — Cut the head Casing to the appropriate length. This will drive the measurements for the fillet and caps. Cut and fully assemble the head casings. We used the PVC Cement & CA Glue combination only. NO nails or screws required. If you choose to use fasteners, cover the holes with a light spackle and sand prior to painting.

Top Photos — We utilized Miter Returns for the top caps to eliminate “cut edges” and ensure proper paint coverage.

Bottom Photos— after completing the miter returns, we assembled a four parts to complete the head casing.

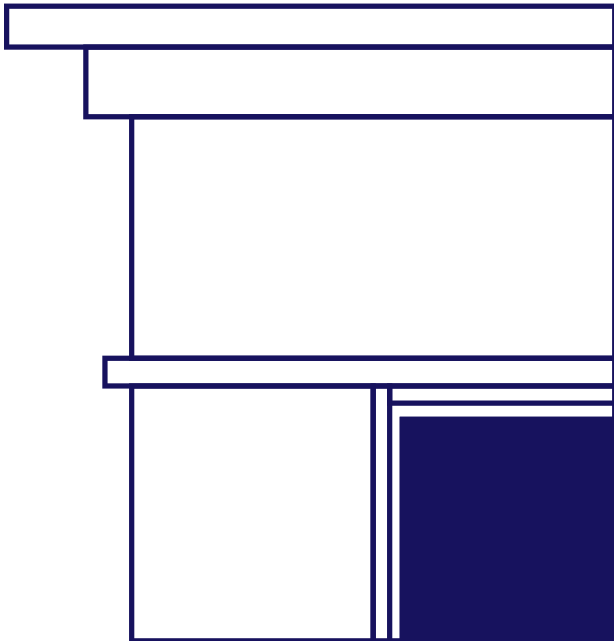

Head Casing



Step 2 — Paint

Painting — we will look at the Good, Better, Best scenarios for applying the Paint to PVC Trim. You can choose based on level of comfort with each process and environmental circumstances.

GOOD — Brushing:

If you choose to brush, the results will vary depending on the atmospheric conditions. Rapid drying paint will tend to leave brush mark texture in the finish.

BETTER — Brushing & Rolling:

The addition of the roller will help provide a smoother texture, but the brush marks will be visible in corners.

BEST — Spray:

This option provides the best finish overall. We used a HVLP gravity feed cup (cost \$60.00) with a 2.2 tip size. We did not reduce the coating and used the manufacturers recommendations for the gun settings. If you have access to an air compressor and an area to paint (outside lawn) this will produce the best finish.

Spray outdoors for proper ventilation. With the HVLP gun, overspray was not an issue. Upon completion, we staged them in the room and allowed them to dry overnight. The coating will dry to touch in about an hour and may be re-coated (if necessary) after two hours. One coat was sufficient for our application.

Painting Process



Step 3 — Install

We will approach this install with a concealed fastener approach. With the finish achieved by spaying the trims, covering nail holes would be difficult. The use of “pining” and interior construction adhesive, we should have no exposed fasteners in the build.

There is a progression to the install . . . from the bottom up! We will start with the plinth blocks (door casing if not using plinth blocks) the install will be in three phases:

Doors —

- Plinth
- Casing
- Head Casing

Windows —

- Stool and Apron
- Casing
- Head Casing

Base Board —

- Base
- Base Cap

Plinth Application —

1. Apply adhesive to the back of the block
2. Position on the wall/door jamb (leave reveal)
3. Toe-screw a trim head screw at the top back portion of the block hidden by the casing.

Plinth Blocks

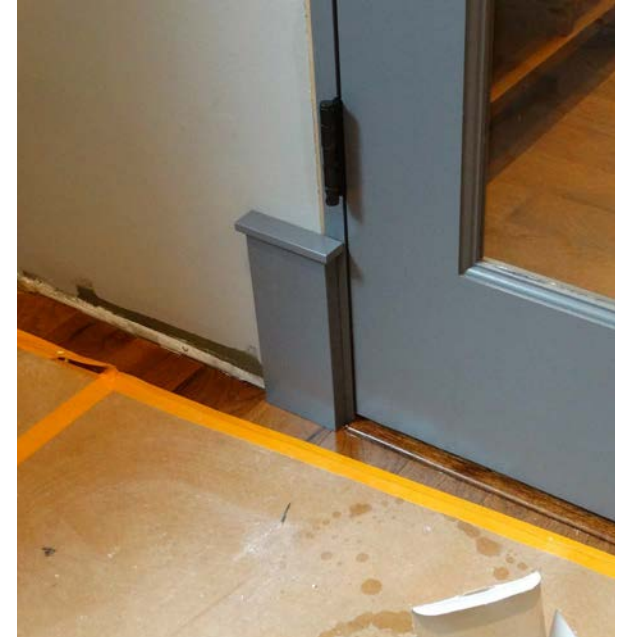

Step 3 — Install

Casing Application —

1. Measure the casing by setting it atop the plinth and transferring the reveal mark. Cut accordingly.
2. Pin both ends of the casing
3. Apply glue to the back of trim
4. Position on the wall, align with the reveal mark, and tap the top of the casing to set pins into place with a hammer.
5. Toe-screw a trim head screw at the top back portion of the block hidden by the head casing.

Pinning the Casing —

1. Drive 2" finish nails into the ends of the trim leaving $\frac{3}{4}$ " exposed
2. Clip the nails about $\frac{3}{16}$ " from the substrate
3. The remaining nail will act as a pin to lock the mating trim.

Casing



Pinning



Step 3 — Install

Head Assembly Application —

1. Apply adhesive to the back of assembled head casing
2. Position atop the casing and align end of head base and outside casing.
3. Lightly tap the header to engage the pins and lock into place

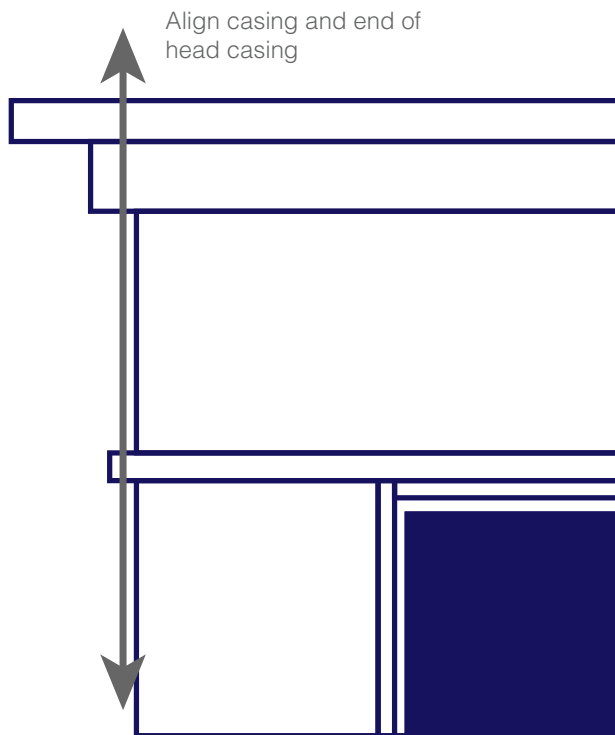

Plinth Blocks

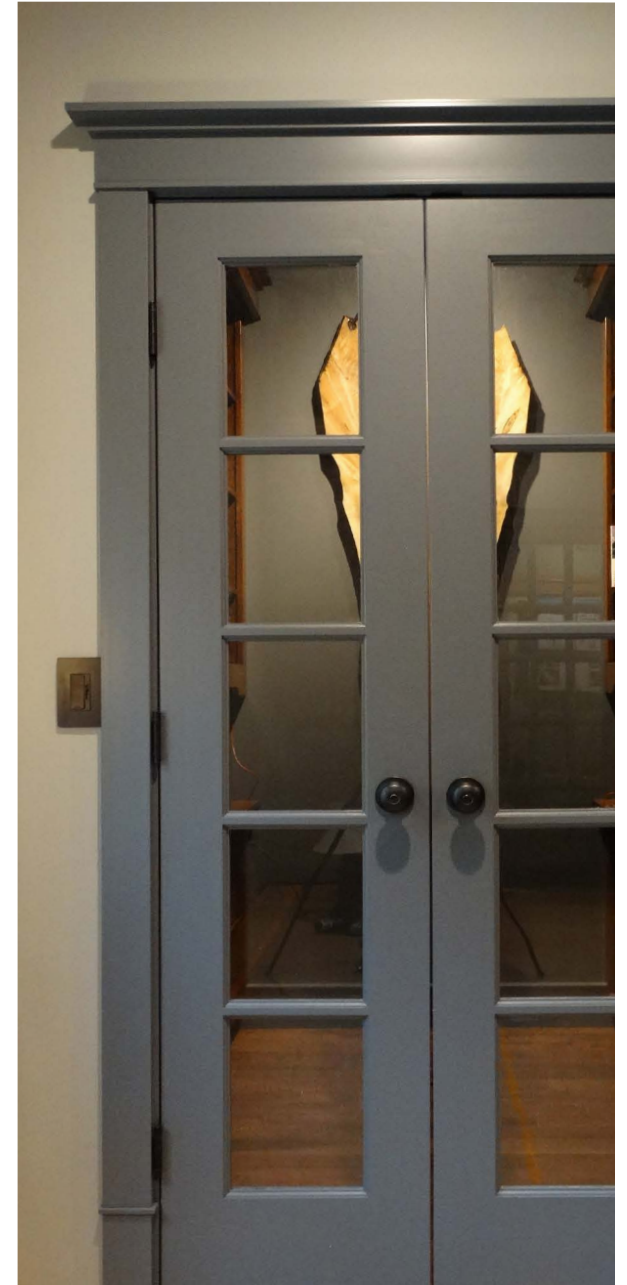

Step 3 — Install

Stool / Apron Application —

1. Measure and notch the stool to rest inside the window opening. The stool should extend beyond the casing. We extended $\frac{1}{2}$ ", but its design specific.
2. The Apron is cut to align with the casing.
3. Apply glue to the back of trims.
4. Position on the wall and align with temporary casing.
5. We used clamps to maintain position as the adhesive set

Pining the Casing —

1. Drive 2" finish nails into the ends of the trim leaving $\frac{3}{4}$ " exposed.
2. Clip the nails about $\frac{3}{16}$ " from the substrate.
3. The remaining nail will act as a pin to lock the casing into the stool.

Plinth Blocks

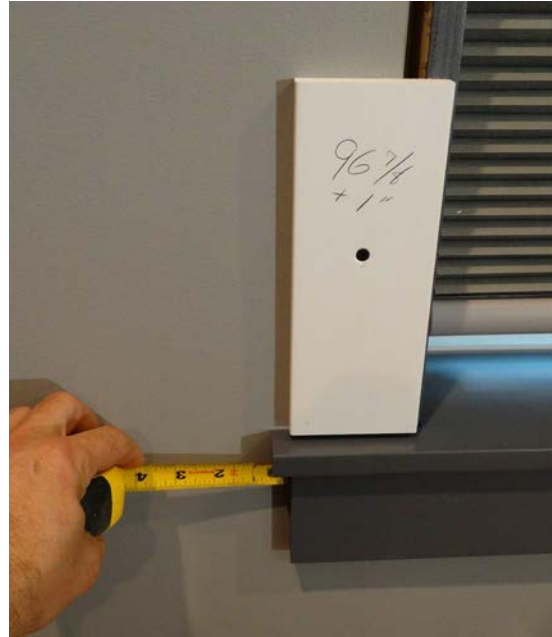

Step 3 — Install

Base Application —

1. Position base against wall and plinth to establish proper length.
2. Cut to size and apply adhesive.
3. Press into place. If additional holding is required, toe-screw trim head screws into the top of the profile. The cap will conceal the fasteners.
4. Place the cap atop the base and mark length and return notch.
5. Cut, glue and press into place.

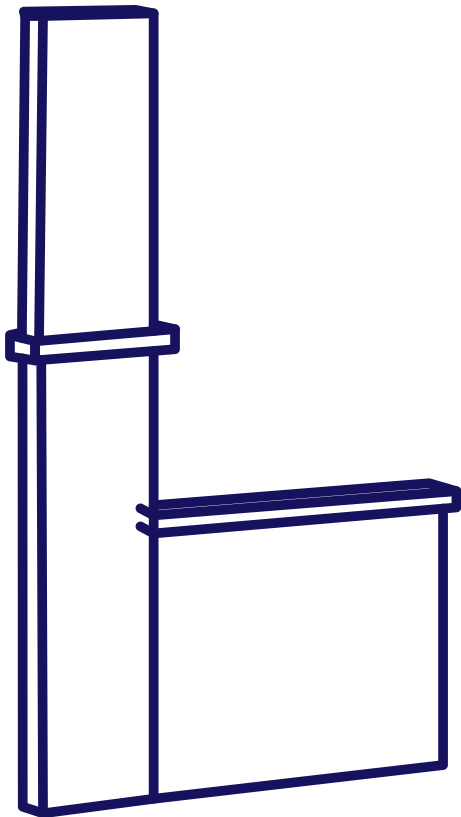

Base & Cap

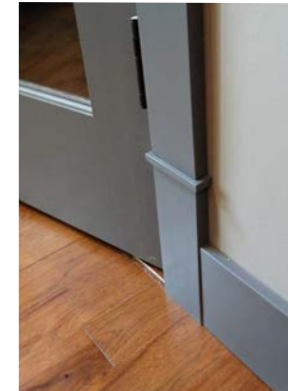



 **ROYAL**[®] Building Products
A Westlake Company

RoyalBuildingProducts.com

1.855.ROYAL85